



KALCO
Handcrafted Since 1980

ASSEMBLY & INSTALLATION INSTRUCTIONS

MODEL: 506651
MIDDLETON 3 LIGHT PENDANT

I M A G E



If you have any questions or problems assembling your fixture please call us for assistance.

Customer Service: (702) 361-4345 or (800) 525-2655
customer.services@kalco.com

WARNING! TO REDUCE THE RISK OF FIRE OR INJURY PLEASE TAKE PRECAUTION AND FOLLOW THE STEPS BELOW.

1. If you are unfamiliar with electrical wiring, call a qualified electrician to install this unit. More than one person may be necessary to install fixture, make sure you have enough qualified help.
2. Turn off the power to the fixture's circuit at the service panel. Use a voltage detector to verify that the power is off.
3. DO NOT install bulb which exceeds the maximum wattage specified on the socket label.

Si vous avez des questions ou des problèmes assemblage de votre dispositif s'il vous plaît appel pour l'assistance.

Customer Service: (702) 361-4345 or (800) 525-2655
customer.services@kalco.com

AVERTISSEMENT! POUR RÉDUIRE LES RISQUES D'INCENDIE OU DE BLESSURES S'IL VOUS PLAÎT PRENDRE DES PRÉCAUTIONS ET SUIVEZ LES ÉTAPES CI-DESSOUS.

1. Si vous n'êtes pas familier avec le câblage électrique, appelez un électricien qualifié pour installer cet appareil. Plus d'une personne peut être nécessaire d'installer appareil, assurez vous que vous disposez de l'aide assez qualifié.
2. Coupez l'alimentation au circuit de l'appareil sur le tableau de service. Utiliser un détecteur de tension pour vérifier que l'alimentation est coupée
3. NE PAS installer l'ampoule qui excède la puissance maximale indiquée sur l'étiquette du socket.

WIRING DIAGRAM

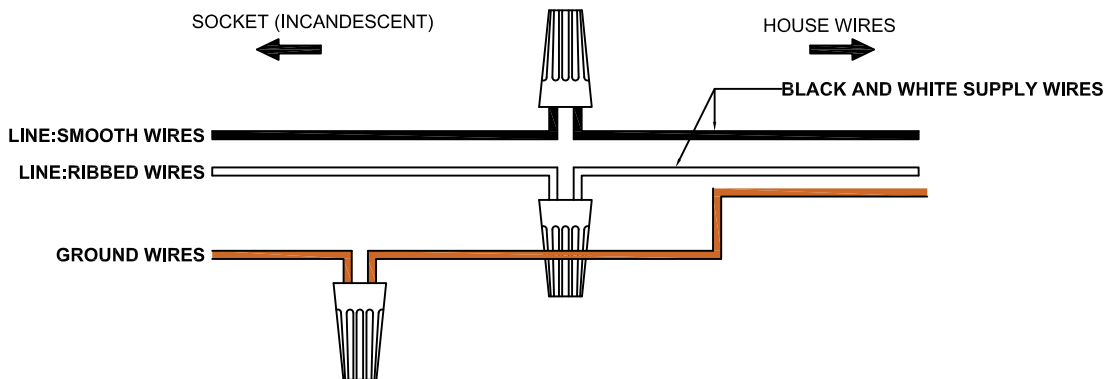



KALCO.
Handcrafted Since 1980

ASSEMBLY & INSTALLATION INSTRUCTIONS

MODEL: 506651
MIDDLETON 3 LIGHT PENDANT

KNOCK DOWN ASSEMBLY

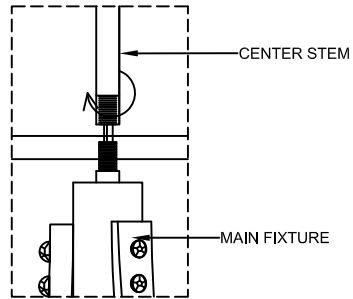
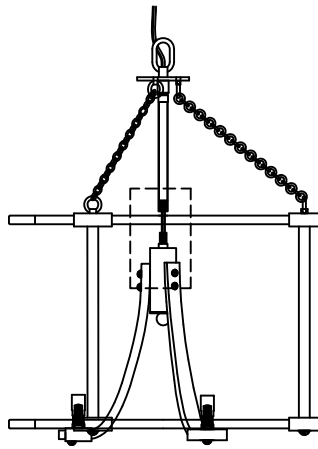

STEP 1: Carefully attach the center stem to the main fixture as shown.

FOR LIGHTING MAINTENANCE:

- Regular cleaning of fixture with proper and gentle care using a soft duster, soft lint-free or damp cloth is recommended.
- Refrain from using harsh cleaning liquids that may cause chemical reaction on the hand painted finishes.
- Always refer to the Assembly Instruction before removing any components.
- HANDLE WITH CARE.



KALCO
Handcrafted Since 1980

ASSEMBLY & INSTALLATION INSTRUCTIONS

MODEL: 506651
MIDDLETON 3 LIGHT PENDANT

ELECTRICAL / MOUNTING INSTALLATION

- STEP 2:** Attach mounting plate to outlet box with the (2) 8/32"x 3/4" screws. Fasten Nipple into mounting plate so that they extend away from the ceiling when the mounting plate is installed. Lock in place using the hex nut and washer provided.
- STEP 3:** Determine fixture height. Make adjustment if needed. Attach chain to the fixture loop and collar loop using open-able chain.
- STEP 4:** Lace wires through the chain links (every other link).
- STEP 5:** Refer to wiring diagram. With wire carefully threaded thru canopy, connect the black supply wire to the smooth fixture wire with wire connector, connect the white supply wire to the ribbed fixture wire with wire connector. Connect ground wire from fixture with supply ground wire.
- STEP 6:** Carefully tuck all wires into outlet box ensuring that there are no wires pinched between the canopy and ceiling.
- STEP 7:** Lock in place using the collar loop ring provided.

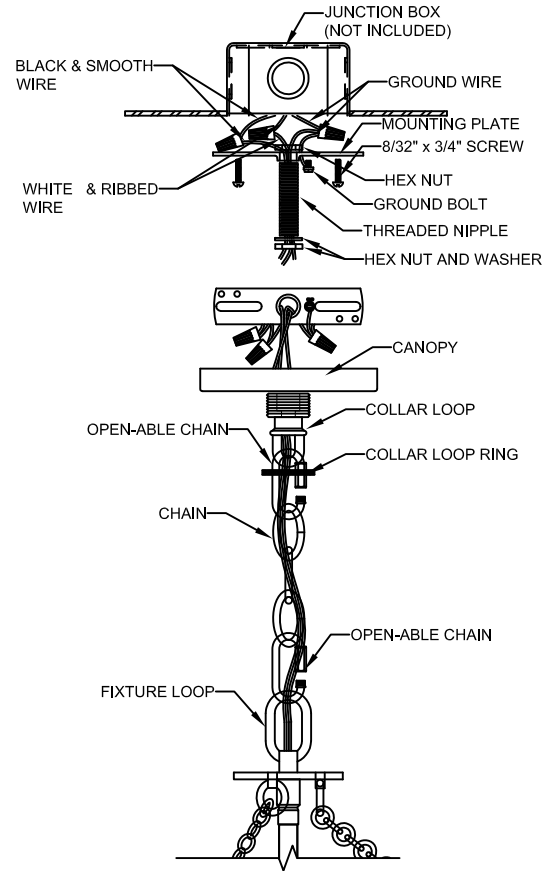

COMPONENT ASSEMBLY

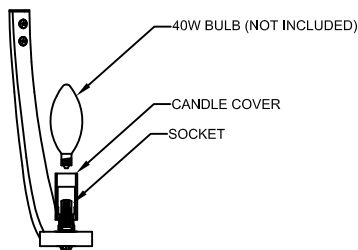

- STEP 8:** Insert candle cover to the socket and install bulb, do not use bulbs that exceed 40 Watts.











KALCO.
Handcrafted Since 1980

ASSEMBLY & INSTALLATION INSTRUCTIONS

MODEL: 506651
MIDDLETON 3 LIGHT PENDANT

PARTS LIST

| IMAGE | PARTS NAME | QTY |
|---|-----------------|-------|
|  | X-9 Parts Bag | 1 PC |
|  | Screw | 2 PCS |
|  | Threaded Nipple | 1 PC |
|  | Star Washer | 1 PC |
|  | Hex Nut | 2 PCS |
|  | Open-able Chain | 2 PCS |
|  | Chain (4ft.) | 1 PC |
|  | Canopy | 1 PC |
|  | Candle Cover | 6 PCS |